

HOW TO USE A ROMAN BLIND KIT

Sewing hems

Measure the width and drop of the window and add the measurements indicated on the white panel (on fig. 1). Mark and cut out the fabric. On wider blinds ensure that all seams are equal from the centre (fig. 2).

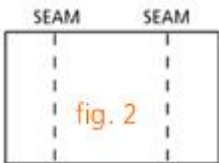
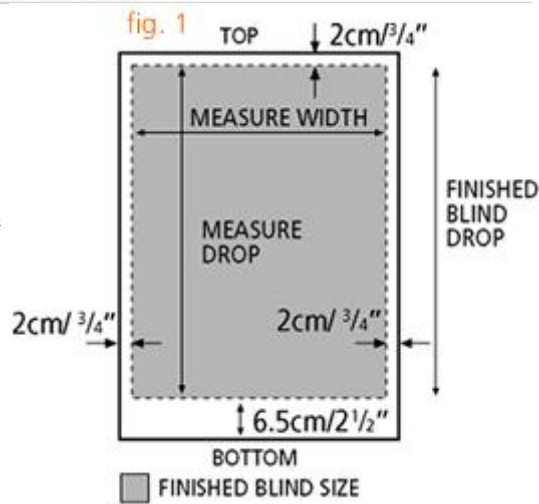

Fold and stitch the side seams (see fig. 3)

Fold and stitch the top seam (fig. 4) leaving the ends open.

Fold and stitch the bottom hem/pocket to leave a 5cm/2" hem (fig. 5) leaving the ends open.

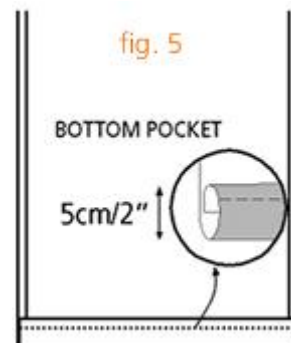
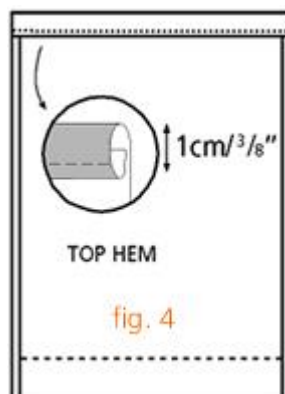
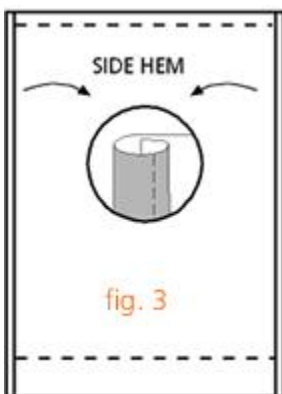

Sewing roman tapes and fitting rods

Decide the number of folds that you require and space distance between as shown in fig. 6.

This is an example only, and personal choice in the number of folds and size of window will determine the finished look. Each pack contains 4 rods to slide into the roman blind tapes, plus one for the top hem slot.

The diagram (fig. 6) shows the calculation for a 125cm/48" drop blind.

fig. 6

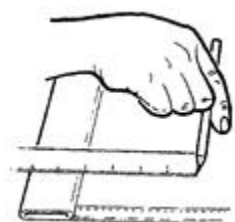
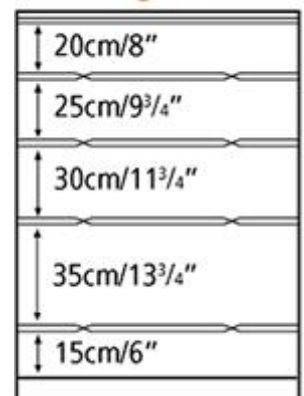

On the back of the blind, measure and mark on each side the positions for the roman tapes.

With a pencil, draw a faint line across the blind to join the marked positions (fig. 7).

NOTE: Ensure that these lines are parallel before stitching.

Cut the tapes to the correct width of the blind. Place tapes blue sewing line uppermost and stitch the tapes in place, sewing along the blue line (fig. 8).

With a hacksaw, cut rods to the same length as the tape and insert into sewn tapes and the top hem (fig. 9).

PRACTICAL TIP: Cover the rod with sellotape at the point of cutting.

Cording up

Cut to size the support rail. Feed the top hem into the channel on the support rail (fig. 10).

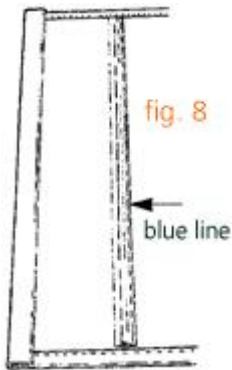
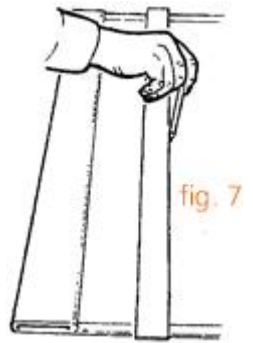

HELPFUL TIP: If fabric is a little thicker, it may be helpful to flatten the ends using a heavy object where there is bulk caused by seams, to make insertion into the channel easier.

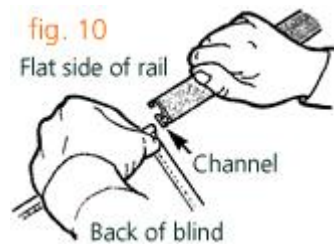
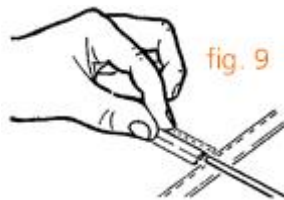

Cut the supplied bottom rod to size and insert into the bottom pocket (fig. 11).

Turn the support rail over so that the blind hangs from the top of the rail. Fit the cord guides, placing these will depend on the number supplied for different sized blinds. Fit guides at a point 5cm/2" in from either end of the track (fig. 12). Position any further guides equally between. Fit end cover (fig. 13).

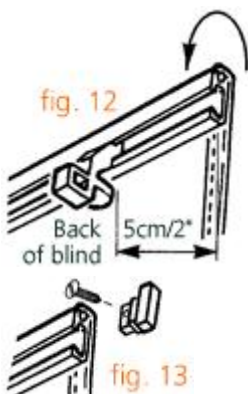

Starting at the opposite side from which you wish to draw. Feed the cord through the bottom row of tape at the appropriate slot, ie. in line with the cord guide. Thread the cord up in line through each row of tape and the cord guide immediately above. Feed the cord through all the other cord guides, working to the draw side of the blind. Decide on the drop of the cord for pulling up the blind and stop at that point. Cut and tie with a treble knot at the starting point. Repeat the above in line with each cord guide (see fig. 14).

Thread the wooden acorn onto the cords. Double knot the cords and pull the acorn over the knot for a neat finish (fig. 15).

Hanging finished roman blind

Mark and fix the Euro supports in position. (We recommend that for plaster walls a wooden batten be secured first).

Make sure that the Euro supports fall in positions between the cord guides (fig. 16).

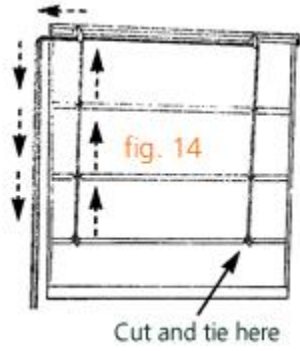

Clip the support rail onto the Euro supports by resting the rail onto position A and press back. To remove the rail depress and release catch B.

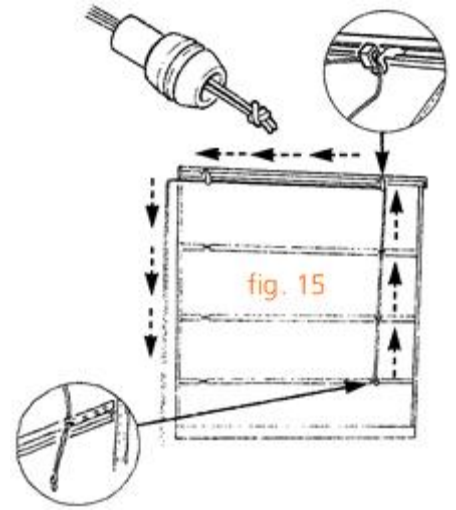

Mark, drill and plug the brass cleat included, to hold the blind in the open position.

